

G&F Manufacturing

Swimming Pool Heat Pump



Install & Operation Manual

For fastest service, please be sure to complete the information below and call - **(239) 567-0009**

Serial #: _____

Install Date: _____

5005001B
Version 5.4

ALDI
MEMBER

TABLE OF CONTENTS

• Introduction	3
• Water Chemistry Maintenance	5
• Installation	
○ Location of Heater	6
○ Tie Downs	7
○ Above Ground Pool	7
○ Initial Programming	7
○ Solar Heat-Pump Hybrid	8
○ Motorized Valve Automation	9
○ Plumbing Sequence	9
• Heat Pump Features	10
• Heat Pump Operation	11
○ Control On/Off	11
○ Pool/Spa Modes	12
○ Changing Set Point Temperature	12
○ Heater Running Time	13
○ Keypad Lockout	13
○ Defrost Cycle	13
○ Condensate Draining	13
○ Pool Solar Heat	14
○ Heat/Cool Operation	15
○ Care & Maintenance	16
○ Cleaning	16
○ Winterizing	16
• Troubleshooting	17
• Wiring Diagrams	19
• Service	21

INTRODUCTION



WARNING:



Non-authorized service may void the warranty.

REGISTER YOUR WARRANTY ONLINE AT:

<http://Gulfstreamheatpump.com/register/>

SERVICE

All warranty service must be handled by an Authorized Service Center. Warranty may be void if a non-authorized service representative does service on the unit. Do not return the heater to your dealer, as they do not provide service. Before calling for assistance or service, please check the Troubleshooting section of this manual or call your dealer. This may save you the cost of a service call. If you still need help, follow the instructions below.

Service can be obtained by calling us at:

(239) 567-0009 or (954) 318-6900

Or schedule service on-line at:

www.Gulfstreamheatpump.com

When asking for help or service please provide a detailed description of the problem, your heater's complete serial number, the purchase date and dealer purchased from. This information will help us respond properly to your request.

Keep a copy of the sales receipt with the date of purchase.

Proof of purchase will verify in-warranty service.

Attention, Warning, and Caution boxes have been placed throughout manual to help point out important information to look out for.



Attention- this will point out important information to be aware of



Warning- this will point out action that might void warranty





Caution- this will point out any safety issue for owners

Congratulations on purchasing the most advanced high efficiency, microprocessor-controlled pool and spa heat pump available. Your heater has been manufactured with the best state-of-the-art quality control equipment available today to ensure the highest quality product delivered to your door. A heat pump pool heater is a highly efficient, cost effective method of pool heating. Proper operation and care will result in many years of swimming enjoyment and pleasure.

Your new pool heater is a self-contained unit designed specifically for swimming pool and spa heating. It utilizes the sun's free energy by extracting heat from the sun-warmed air and transferring it efficiently to the pool water. Because your pool heater moves the free heat from the outside air to the pool, rather than create heat, as a fossil fuel or electric resistance heater does, it can heat your swimming pool or spa for up to 80% less cost than these other less efficient methods.

As with all pool heating methods, you are advised to utilize a pool cover at night and when the pool is not in use. The pool cover should be used if the night temperature is 15°F (8°C) less than the desired pool temperature. This will keep evaporation, the greatest source of heat loss, to a minimum, greatly reducing the overall pool heating costs. During warmer weather, the pool cover may not be required.

Your pool and spa heater combines simplicity with trouble-free performance. As with most appliances, an understanding of proper operation of the heater is important. Proper installation and operation increases efficiency and reduces heating costs. Your pool heater is designed with features that make it simple to operate, maintain and service. This manual will provide you with the information needed to properly operate and maintain your heater.

 ATTENTION:  Please be sure to complete and mail in the Warranty Registration Card that is provided in the package with your heater. This card provides us with your information in case you need service.
--

Also, please take a moment and jot down the following information. If you should ever need to call us for service or a question, we will need this information:



Serial Number: _____

Purchase Date: _____

Dealer Name/Address/Phone #: _____

WATER CHEMISTRY MAINTENANCE



Not only is the water chemistry of your pool or spa important to the health of you and your family, it also directly affects the life of your heater. This is the most important item in the maintenance of the heater. If the water chemistry is improperly maintained or if the chemicals are improperly introduced into the water, this may damage the heater's internal components and could eventually cause a leak, rendering the heater inoperable.

 WARNING:  Damage to the heater due to improper water chemistry Is not covered under the warranty.

Following is the table for essential water quality readings, which should be constantly maintained:

Description	Normal Range	Verify
PH Level	7.4 to 7.8	1 time per week
Chlorine Concentration	1.0 to 3 PPM	1 time every 2 to 3 days
Total Alkalinity	80 to 120 PPM	1 time every 2 to 3 weeks
Total Dissolved Solids	Below 2400 PPM	1 time per month
Calcium Hardness	200 to 300 PPM	1 time per month

The location of the chemicals' introduction to your system is also critical to the heater's life. If an automatic in-line Chlorinator or Brominator is used, it must be located downstream of the heater. A Trap/ Check Valve should also be installed between the chlorinator and the heater to prevent chlorine return into the heater.

 WARNING:  Never leave any type of solid chlorine in the pool skimmer. This will cause a high concentration of Chlorine to enter the heater, causing premature corrosion. Never add chemicals into the pool skimmer.
--

INSTALLATION

LOCATION OF HEATER

The unit is designed for outdoor installation and shall not be placed in a totally enclosed area such as shed or garage. This will cause recirculation of cold discharge air back into the evaporator coil and will greatly reduce heating capacity and efficiency of the unit. This may void the compressor warranty since it is over working the compressor.

If the unit is installed at the edge of a roofline, make sure the roof has a rain gutter to prevent water from the roof pouring into the heater.

The heater should be located as close to the existing pool pump and filter to minimize water-piping length to reduce pool water head loss.

Your heater features an up-flow fan for quiet operation. Air is pulled through the evaporator coil and discharges through the top of the grill. **At least 4 feet clearance should be allowed above the unit for unrestricted air discharge.** The unit must not be installed under a porch or any kind of overhang this will also cause cold air recirculation.

All sides of the heater should have at least 12 inches of clearance to allow enough air to flow through the evaporator coil for optimal heating. Restricting one side of the evaporation coil is permitted, however it will cause a decrease in efficiency.

The unit should be mounted on a flat surface, preferably on a concrete or fabricated pad. The surface should have a slight grade so condensation will drain off the pad. The unit should be completely isolated from the building foundation or wall; this will prevent the possibility of vibration sound transmitting into the building.



WARNING:



Make sure that there are NO SPRINKLER HEADS near or directly with in spraying area of the heater. This may cause expedited corrosion of the unit

TIE DOWN STRAPS

The base of the unit may be used to fasten the unit in accordance with your local building code. Attach two tie strap on opposite sides of unit (See diagram HS1) and anchor to the deck.

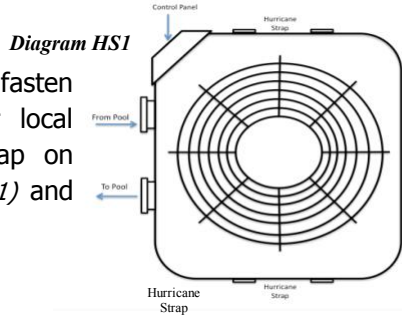

Pool Level Above Heat Pump Installations

When installing a heater below the pool level (and some solar installs), adjustment to the pressure switch must be completed or the manufacturer may require an external flow switch. This is to prevent the pressure switch from falsely indicating water flow due to high head pressure of the water. Failure to use an external flow switch may cause the unit to activate without water flow. The unit may go into "WATER FLOW LOCKOUT". You may install the flow switch on the inlet or outlet side of the plumbing. Wire the flow switch into the space marked WPS located on the bottom right corner of the board. (See Diagram FS1).

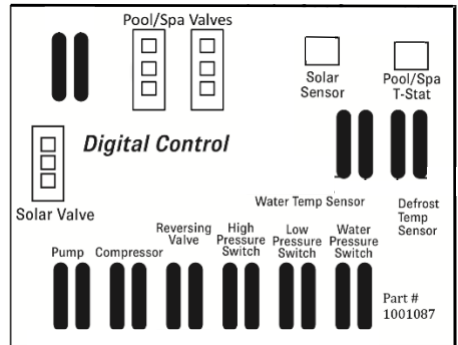

Diagram FS1

Initial Installation Programming

Upon initial powering up of the unit, "LANGUAGE SELECT" will appear on the display. Select your desired language and press "MODE", select °F/°C and press the "MODE" button to get to the "TEMP SCALE" selection. This install menu will be on the display for 30 Seconds then the display will change to the Operation Menu. From the Operation Menu you can adjust the set point. If the 30 seconds finished and you still need to adjust any of the settings, cut the power off to the board and turn back on. The board will display the "LANGUAGE SELECT" screen again for another 30 seconds. The factory setting is English and °F.

Sub-Menu Access

To access the programming sub-menu (remote t-stat, solar, heat/cool, calibration, load defaults etc) press and hold the up arrow and down arrow at the same time until the board displays "remote t-stat". Use the MODE button to scroll through the options and use the arrows to change settings.

If there are issues with the operation of the board, we suggest that you "Load Defaults" to return to factory settings.

Solar Heat-pump Hybrid System Install Instructions

This option will allow the Heat Pump to monitor the performance of the pool's solar heating system, and will automatically divert the water away from the solar to prevent overheating or cooling of the water.

Installing a Hybrid System:

Installing the Solar after the Heat Pump:(Factory Recommended)

This form of the Hybrid System is the recommended installation from the factory. Plumbing the Solar system after the heat pump will prevent from having flow issues and from getting an incorrect current water temperature.

Installing the Solar before the Heat Pump:(Not Recommended)

If you choose to install the solar before the heat pump you need to make sure that you install a water temperature sensor on the water line after the filter and before the solar. Otherwise you will not get the current water temperature on display screen. This can cause the heat pump to shut off before it reaches the set point. The new sensor must be attached to the board on the spades where the current WTS is attached.

Enabling the Solar Control:

Press and hold the UP and the DOWN arrows till the service menu appears. Use the "MODE" button & scroll, when you see "SOLAR CONTROL", Press the UP or DOWN arrow to "ENABLE", Do not touch anything else. The board will automatically return you to the main screen.

Setting Temperature for Heat pump, and Solar:

To set the temperature, press "Mode" button until "Pool- Solar Heat" displays on screen. Press the UP arrow until "POOL TEMPERATURE SETPOINT" displays on screen. Once you set the desired pool temperature, then press the "Mode" button so that the screen reads "POOL SOLAR SETPOINT", set the temperature desired for the solar. The temperature set point for the heater can be lower than solar, but cannot be set higher; the heat pump will run until the set point for the heater is satisfied.



WARNING:



Make sure if you are installing heater to an existing solar system, please check the condition of the low voltage wires.

Installing Motorized Valve Automation

To install actuators, run wires from the actuators into control box of the unit. Then connect the wires to the Pool/Spa valves terminals on top of the board (*See Diagram MVA1, may need flow switch*). Make sure you can the valves correctly before running water through the system.

Operation of Automation

There are two ways you can operate the automation:

1. Use the MODE button on the unit to switch from Pool to Spa.
2. Wire an external switch to the T-Stat Pool/Spa terminal on top right hand corner of board (*See Diagram MVA1*) there is no programming. Activating the external switch will change the mode and valves from Pool to Spa. This can also be activated by a network communicating switch via an App on your mobile device. Additional wiring required.

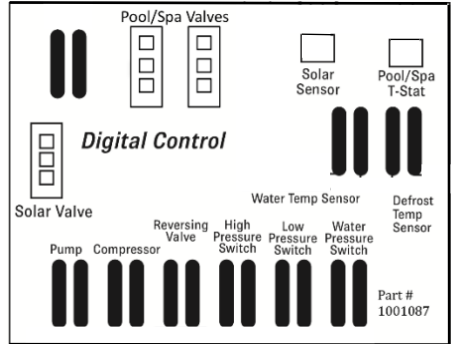
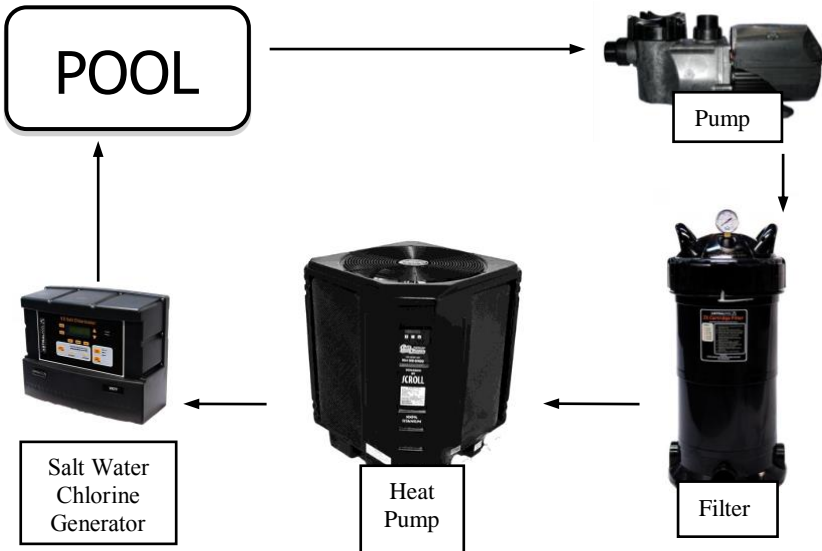

Diagram MVA1

Plumbing Sequence

The piping sequence is pool pump – filter – heater – solar - chlorination system(s) – pool. Rigid PVC piping is recommended and all joints secured with PVC glue. Installation MUST conform to all local codes. Make sure water-flow is correct as indicated on back of heater. Again, try to keep piping away from areas that may be tripped over or stepped on when operating heater or servicing. Try to keep elbows and piping to a minimum to avoid excessive pressure drop. We use a full-flow heat exchanger so no external bypass is needed up to 70 GPM.



HEAT PUMP FEATURES

CABINET

Your heat pump's cabinet is made from a maintenance-free, rust-free ABS plastic that is UV resistant. It will last for years and any dirt or dust may be wiped away with a cloth. Use only cleaner designed for plastic.



CAUTION:



DO NOT USE CLEANERS THAT CONTAIN ALCOHOL.

CONTROL

State-of-the-art Blue LCD readout control display. Displays mode and temperature of the water for ease of operation. No programming to learn. Dual thermostats allow user to set pool and spa temperatures. Off mode allows easy way to shut off heater. The control is self-diagnostic and will display a fault if there is a problem. Other features include: lockout, spa timer, automatic low temperature defrosts, remote control capabilities, even-heat, motorized valve operation and solar control.

ULTRA-QUIET

The unit is equipped with a low RPM fan motor in combination with a deep drawn venture and engineered fan blade to ensure whisper quiet operation.

HIGH EFFICIENCY

The heat pump utilizes the latest in compressor technology to produce the highest efficiency available when coupled with the over-sized enhanced fin evaporator coil, and rifled titanium tube heat exchanger.

EASE OF INSTALLATION

The unit is equipped with easy-to-install, hand-tightened unions for a quick and trouble-free installation. The unions will accept 2" PVC piping. The electrical connection is made with one entry directly into the control box for a quick hook-up and a neat appearance.

Heat Pump Features Continued

EASY ACCESS

The heater was designed for quick and easy access for installation and diagnosis. The service panel is removed with four screws and access to all service connections are right up front and easy to reach. This allows the installation and service to be done quickly and efficiently – so valuable time is not wasted.

MOTORIZED VALVE CONTROL *(Additional wiring required)*

The Board now has terminals for your motorized valves; this will allow your heater to switch the valve from pool to spa by just pressing the "MODE" button.

SOLAR CONTROL *(Additional wiring required)*

The board can be set to run and monitor your pool solar system. There is no need to have a second and separate control system.

EVEN-HEAT *(Additional wiring required)*

This feature allows the heater to periodically turn pool circulation pump on and test water temp. If temp is below the set point programmed on board, the heater will run the pool pump until it reaches set point, then it will shut the unit and the circulation pump back off. This feature can be set to run in one-hour increments. This feature is after paired with the GPS feature (pg 15)

HEAT PUMP OPERATION

POWER OFF

In order to shut Heat pump off, press the "MODE" button until it reads, "POWER OFF", while in "POWER OFF" the unit will not run. To get out of "POWER OFF", press the "MODE" button, that will lead you to the "POOL - HEAT" screen where you can continue normal operation. Solar control will not update in "OFF" mode.



CAUTION:



When the control is in the "OFF" mode, there is still high voltage to the unit. If you want to turn the unit off for long periods of time, shut the main power off to the unit at the main or service disconnect.

POOL/SPA MODES

The control is equipped with two independent thermostats, one for pool temperature and one for spa temperature. This is to allow user to preset a temperature of their choice and switch between the two settings with the "MODE" button located on the control. When water is flowing through the unit and the water temperature meets the specified set point condition, the control will turn off the heater.

If you do not have a spa, you can use the spa thermostat as a second temperature setting if you do not want to maintain full temperature all the time. For instance, if you swim on the weekends only, you can set the temperature back during the week to save costs but maintain a warmer temperature for a shorter recovery time for the weekend.

The display on the control will show the thermostat being used and the operating mode on the top line and the current water temperature on the bottom line. The Standard mode displays are: "POOL – HEAT", "SPA – HEAT", "POWER OFF". "POOL-COOL", "POOL- HEAT/COOL", "POOL SOLAR HEAT" will also be available if enabled in the service menu. Addition programming and wiring may be required for these features to be activated.



ATTENTION:



There is a 120 Second time delay upon initiation of a heating cycle. This is to ensure that the critical components do not fail due to short cycling of the heater. A count down will be provided on the display.

CHANGING SET POINT TEMPERATURE

To change the set point temperature, press either the "Up" or "Down" arrow buttons on the control. The display will then show "POOL or SPA TEMPERATURE SET POINT" on the top line and the current set point temperature in numbers on the bottom line. After adjusting to the desired temperature setting, the display will revert to "POOL or SPA – HEAT" on the top line and the pool temperature in numbers with "DEGREES" on the bottom line. After 5 seconds of inactivity and the new set point will be stored in memory. The default factory setting for Pool temperature is 85° Fahrenheit (F).

HEATER RUNNING TIME

The owner is responsible for determining the necessary length of operating time for the pump and heater based upon users particular requirements. Most units are sized to operate during the pool filtering cycle time of 8 to 10 hours daily, providing an even, steady flow of heat. On warmer days the heater will run less because there will be less heat loss from your pool. The heater is capable of running 24 hours per day if necessary. When you first run your heater, it may need to run continuously for 24 to 48 hours to get the pool up to the desired temperature. The heater operates most efficiently when operated during the warmest hours of the day.

KEYPAD LOCKOUT

While in any mode the user can lockout the keypad by pressing and holding the "MODE" button for 6 seconds. When the keypad "LOCKED" has been enabled all buttons are disabled and the control will operate in whatever mode it was in when the lockout occurred. Any button push while in "LOCKED" will cause the display to show "LOCKED" for 5 seconds. To unlock the Keypad, press and hold the "MODE" button for 6 seconds. The display will show "UNLOCKED" for 5 seconds.

DEFROST CYCLE

The heater is designed to enter the defrost cycle at ambient air temperatures below 48° Fahrenheit. During this cycle, the unit may shut down and the control will display "DEFROSTING" until the ambient air temperature rises above frosting conditions. Hot Gas Defrost in certain models is available – Allows unit to operate in the mid 30's °F. This feature must be enrolled in the service menu, unit will not operate below 35° F.

CONDENSATE DRAINAGE

It is normal for water to be draining from your heater. This occurs because the evaporator coil condenses the water from the air. The water drains into the base of the unit and out the holes that are located on each side of the heater at the bottom. **Your heater can produce up to 3 gallons of water per hour.** The water created from the condensation will dry up when the heater is shut off.

POOL SOLAR HEAT OPERATION

Once the Solar Control is enabled in the Hidden Menu, and 20 seconds of inactivity, the Screen will return to display "POOL-HEAT"

Press "MODE" button to display "POOL-SOLAR HEAT" on the front screen, the display will show as follows in illustration 1

P	O	O	L		S	O	L	A	R		H	E	A	T	
					8	0	°	F			1	2	0		

(Illustration 1)

By pressing either "UP" or "DOWN" the screen will show "POOL TEMPERATURE SET POINT", as follows on illustration 2. The user can adjust the set point by pressing Up and Down buttons until the desired set point is reached.

P	O	O	L		T	E	M	P	E	R	A	T	U	R	E
S	E	T	P	O	I	N	T					8	2	°	F

(Illustration 2)

By pressing the "MODE" button once your pool temp set point has been set, you will see "POOL- SOLAR HEAT SETPOINT" on display as in illustration 3

P	O	O	L		-	S	O	L	A	R		H	E	A	T
S	E	T	P	O	I	N	T					8	8	°	F

(Illustration 3)

Using the "UP" or "DOWN" arrow to adjust the desired Solar set point, the board will display "POOL-SOLAR HEAT" after 5 seconds of inactivity.

The Heat Pump will be engaged only when water temperature falls 1° below user's "POOL TEMPERATURE SETPOINT".



ATTENTION:



Solar set point can only be equal or higher than the Heat Pump set point. For energy efficiency solar heat will take precedence over the Heat Pump when respective set points are equal.

HEAT / COOL UNIT OPERATION

CHOICE ONE

HEAT/COOL

(OPTION 2 IN SERVICE MENU)

This will allow your Heat Pump to keep the temperature in your pool at the same temperature, if the water temperature get 2° warmer or colder, the unit will heat or cool the pool until it reaches the set point

Programming Instructions:

1. Access the service menu by pressing and holding the "UP" and "DOWN" at the same time, until the screen changes to "REMOTE TSTAT" (Default "DISABLED")
2. Press the "MODE" button until screen reads "POOL – HEAT/COOL" (Default "DISABLED")
3. Press the "UP" or "DOWN" to "ENABLE" this feature.

Operation Instructions:

1. Press the "MODE" button; The Display will read "POOL – HEAT/COOL"
2. Press the "UP" or "DOWN" until screen reads "POOL TEMPERATURE SETPOINT"
3. Use the "UP" or "DOWN" arrow until desired temperature is on display.
4. While still in the "POOL TEMPERATURE SETPOINT" screen press the "MODE" button to set the "DEADBAND" This will regulate how many degree until the unit kicks on heat or cool. (Default is 2°)

CHOICE TWO

HEAT OR COOL

(OPTION 3 IN SERVICE MENU)

This will allow your Heat Pump to independently heat or cool your pool.

Programming Instructions:

1. Access the service menu by pressing and holding the "UP" and "DOWN" at the same time, until the screen changes to "REMOTE TSTAT" (Default "DISABLED")
2. Press the "MODE" button until screen reads "POOL – COOL" (Default "DISABLED")
3. Press the "UP" or "DOWN" to "ENABLE" this feature.

Operation Instructions:

1. Press the "MODE" button; The Display will read "POOL – COOL"
2. Press the "UP" or "DOWN" until screen reads "POOL TEMPERATURE SETPOINT" the unit will cool until it reaches this temperature.

CARE & MAINTENANCE

CLEANING

There is not much maintenance that needs to be done on your heater. Making sure there is good airflow through the evaporator and proper drainage are the two main tasks. A garden hose with low-pressure water flow can be used to clean the evaporator coil, DO NOT spray the control box. Keep all shrubs trimmed back away from the unit to allow sufficient airflow. Clean the coil as needed. If located near the ocean, cleaning will need to be done regularly to remove salt and sand. Use a very soft brush so as not to bend the coil fins with soapy water to remove any build up.



CAUTION:



Make sure all power is disconnected to the heater prior to washing.

Keep the drain holes in the base free of debris to assure proper condensation drainage.

Your heat pump's cabinet is made from a maintenance-free, rust-free plastic that is UV-resistant. It will last for years and any dirt or dust may be wiped away with a cloth or sprayed off with a water hose. Only use products designed for cleaning plastics.



WARNING:



DO NOT USE CLEANERS THAT CONTAIN ALCOHOL.
Alcohol based cleaners may damage the plastic.

WINTERIZING

In areas where freezing condition is not prevalent and winterizing of pools is not common, allow water to flow through the heater even when not in use.



ATTENTION:



In freezing areas, it is MANDATORY that the water be completely drained from the heater and disconnected from the piping. The heat exchanger must be blown out with air to ensure no water is left in the heat exchanger.

TROUBLESHOOTING

A simple test to verify that your heater is functioning is to place your hand above the unit. There should be cool air blowing out the top after time delay has expired. The return water to the pool should be a few degrees warmer than water entering the heater. After about 15 minutes of run time, there should be water draining out of the base of the unit. If you have reason to believe your heater is not functioning properly, follow the troubleshooting guide below, If the unit is still having issues please call for service.

Unit has a blank display:

Check Breakers or Fuse to make it has not blown

Try to reset the breaker by flipping it off and then back on, if you still do not get display on board, you may need to have an electrician to make sure the fuse or breaker is still in working condition.

Unit has water coming out of bottom of unit:

Turn the Heater off, but allow the Pool Pump to continue to run.

Come back after about 1 hour, if the water stopped coming out of bottom of unit, it is just condensation.

If water still coming out of the bottom of the unit, then you have a water leak inside of the unit.

Heater is heating slowly or not getting up to temperature:

Low or restricted water flow through the heater

You may need to clean or replace the filter

Check the pool pump to make sure you are getting about 40-50 GPM through the unit

Be sure variable speed pumps are set to provide 40-50 GPM

Air leak in system

Repair any air leaks in plumbing

Pool Pump Run Time

Make sure you are allowing the pool pump to run long enough, try to allow unit to run longer.

Strong wind in pool area

This may cause water to lose a large portion of heat from the wind, try to install some type of windbreak around the pool

Use of a pool blanket will cut down the amount of heat loss you experience

I see a countdown on my display and my unit is not kicking on:

Delay is a 2-minute waiting period to allow the unit pressures to balance out. Once the count-down reaches zero, the unit should kick on.

Unit Displays No Flow or Water Flow HP:

Check to make sure the Pool Pump is on and primed

If pump is off, or not primed it will not send any water through the system.

Check any bypass valves

Make sure they are not redirecting the water away from the unit you want to make sure that you are getting anywhere from 30 GPM to 70 GPM through the unit.

Check the pool filter to make sure it is clean

If filter is dirty then the unit will not receive the correct amount of water. Make sure that the filter is being cleaned or replaced when is necessary.

Unit Displays Water Flow Lockout:

Once the unit has had a Water Flow HP 3 times the unit will lockout

Check the same flow issues for No Flow and Water Flow HP

If flow issues have been addressed the hold the down arrow for 5 seconds to reset the lockout.

Unit Displays Low Refrigerant Pressure:

Unit low-pressure switch was activated

Call For service.

Unit Displays Max Water Temperature:

Check to make sure you do not have a secondary source of heat feeding hot water into the unit

If no secondary source of heat call for service.

Unit Displays Water/ Evap Sensor Malfunction:

Unit Water or Evaporator Sensor needs some service

Call for Service.

Unit Displays Solar Sensor Malfunction:

Check to see if you have a solar system.

If so, then you need to have the sensor on the roof checked out.

If not, then someone has enabled this feature in your board.

Load Defaults or Call Office for Service.

Unit Displays Even Heat Lockout:

Even Heat is a feature the requires additional wiring and installation of a secondary contactor

If you have a the Even Heat Feature

The signal has an interruption and needs to be checked out prior to having service on the heater.

If not, then someone has enabled this feature in your board. Call Office for Service.

Unit is Making a Loud Noise:

Check to see if the sound stops after a while of running.

If it stops making noise after while it may be the compressor starting backwards.

This can occur sometimes, may not need service as long as it corrects itself.

If noise does not stop call office for Service.

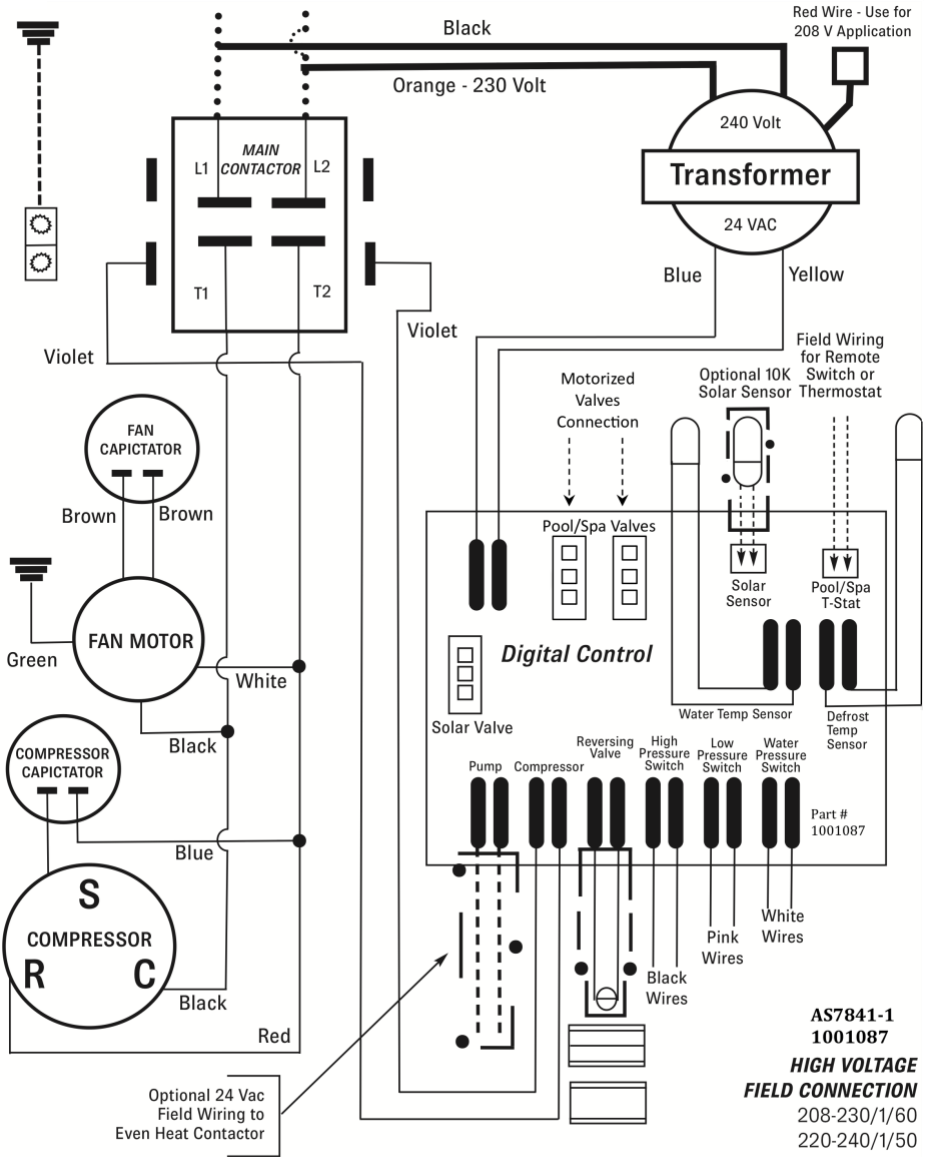
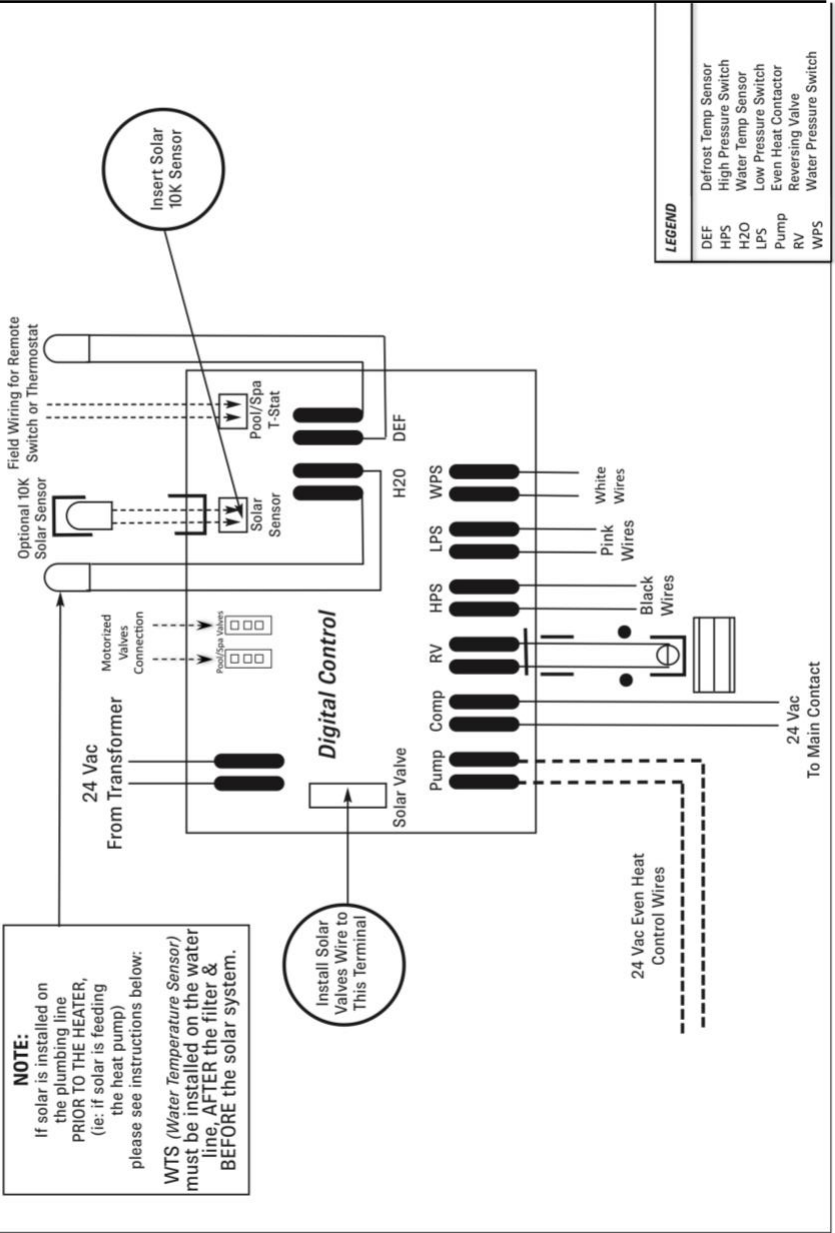



Diagram: Wiring in Solar Heating

G&F Manufacturing
 3902 Interstate Court • N. Fort Myers • FL • 33917
 Phone: 239.567.0009 • Fax: 239.567.1907





WARNING:



Non-authorized service may void the warranty.

SERVICE

All warranty service must be handled by an Authorized Service Center. Warranty may be void if a non-authorized service representative does service. Do not return the heater to your dealer, as they do not provide service. Before calling for assistance or service, please check the Troubleshooting section of this manual or call your dealer. This may save you the cost of a service call. If you still need help, follow the instructions below.

Service can be obtained by calling us at:

(239)567-0009 or (954) 318-6900

Or schedule service online at:

www.Gulfstreamheatpump.com

When asking for help or service please provide a detailed description of the problem, your heater's complete serial number, the purchase date and dealer purchased from. This information will help us respond properly to your request.

Keep a copy of the sales receipt showing the date of purchase.

Proof of purchase will assure you of in-warranty service.

REGISTER ONLINE AT:

<http://Gulfstreamheatpump.com/register/>

MANUFACTURED BY:

G & F MANUFACTURING, INC.
7902 INTERSTATE COURT
239-567-0009

